

# PURUS

Purus Wetroom, Shower, Ensuite and Bathroom Drainage Solutions



[www.purusgroup.com](http://www.purusgroup.com)  
[www.purus.se](http://www.purus.se)



# Experience the possibilities with Purus Line Living

Wetrooms are the fastest growth area in the UK sanitary and bathroom sector.

Wetrooms already account for 8% market share in the UK Bathroom sector. This figure is rising rapidly with Wetrooms being very much in demand by younger and older generations as well as the disabled. In 2011 it was estimated that there were 260,000 Wetrooms installed in the UK.

The Purus Linear Wetroom Solution allows quick and easy showering, easy level access, easy maintenance, the use of larger tiles which create a minimalistic and modern design for the consumer especially for larger format tiles.

Purus have created an easy to install Wetroom that is fashionable, functional and spacious.

A linear Wetroom allows for easy access which does not compromise the design of your Wetroom.

[www.purusgroup.com](http://www.purusgroup.com)



# Many different possibilities

2 different lengths and 3 patterns

## A matter of taste

Purus Line Living is available in 2 different lengths, from 600 mm and 800mm. The shape opens up completely new opportunities for exciting designs in the bathroom. The pattern of the grating you choose is a matter of taste.



## Purus Line Living – Tile

The tile insert grate allows for a minimalistic look and an uninterrupted tile design across the floor, which ensures that maintaining a Wetroom has never been simpler.



The Linear Wetroom Solution accommodates tiles up to a thickness of 10mm with a 3mm bed of tile adhesive. The outlet is made of Polypropylene (PP) plastic and is designed to be self cleaning. It has falls built into the product for ease of maintenance so there is no dirt and odour build up. The unique NOOD trap does not allow any smells or odours to come up from the waste pipes even if it dries out.

**Would you like a grating with a unique design?**  
Contact your Purus dealer for help with your own grating design.

With Purus Tile grating you can choose the same tile in the grating as in the rest of the room.

### TILE differs from the other frames as follows:

- The tiles shall be put in the lowered area in the frame.
- NOTE! The TILE frame cannot be adjusted in height.
- The TILE frame is narrower and shorter compared with the channel and the other models of frames.



Dimensions & CADs available at [www.purusgroup.com](http://www.purusgroup.com)

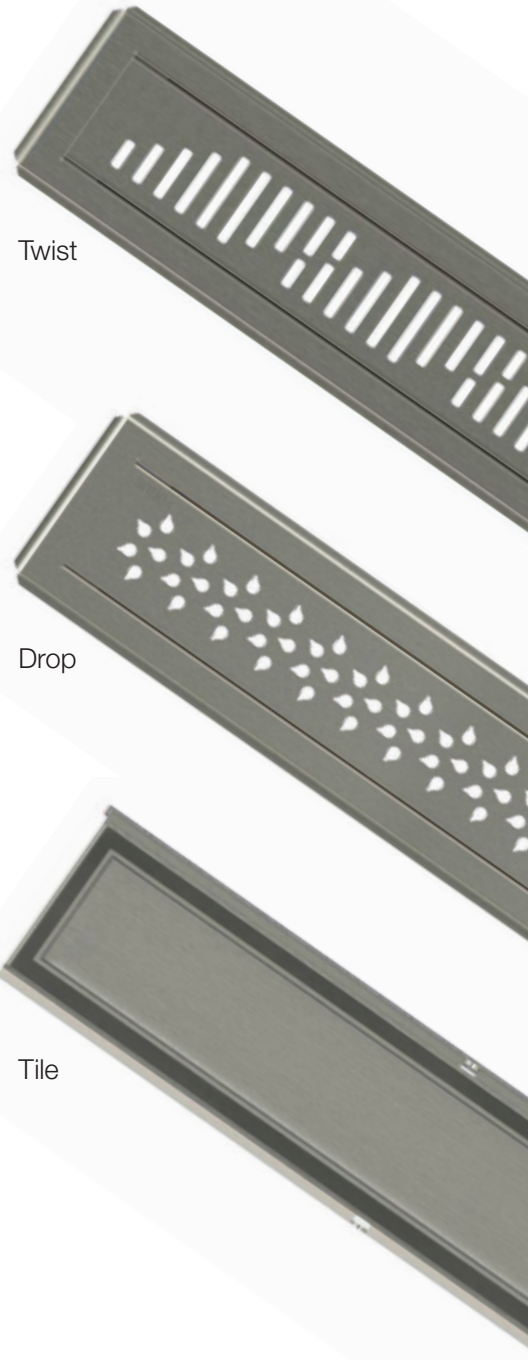

# The flexible solution

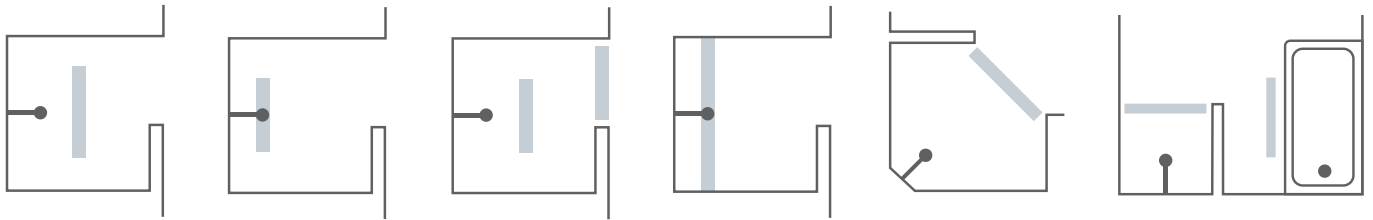

## Purus Line Living Trays

The Purus Wetroom Tray is designed to go on top of floorboards to make the installation process very easy. It has falls built into the tray for the shower water to flow into the gully. Also it can be cut to size and scribed to the wall if required.

The thickness is 18mm and can be used in conjunction with 18mm Marine ply on Floorboards. It comes in one piece for ease of installation with packers for 22mm floor.

The wall and floor joints are also taped and sealed with the Tanking Kit giving it a threefold waterproofing process.

**Please view the installation video [www.purusgroup.com](http://www.purusgroup.com)**

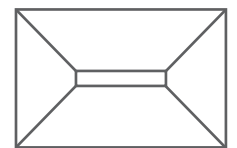

**600mm Living**  
1400mm x 920mm

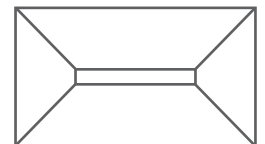

**800mm Living**  
1600mm x 920mm

## Wetroom Tanking Kit

The Tanking Kit is designed to waterproof plasterboard, concrete and Marine ply in your wetroom before tiling.

The Tanking kit is waterproof not water resistant. The Lastogum Membrane is water based and the primer allows the Lastogum to keep its elastic properties by not allowing it to dry out. The Tapes are elastic and accommodates any movements of the wall/floor and corner joints. The Lastogum is easy to tile upon as it gives a mechanical key.

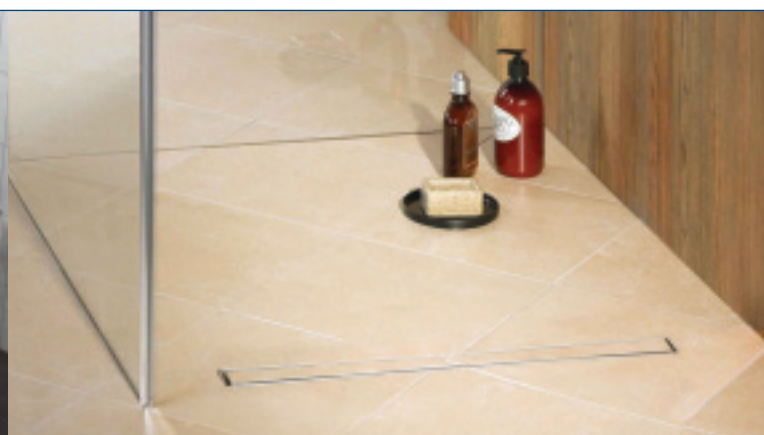

# Purus Project

For installation with clamping frame for both tile and vinyl floor.



### Adjustable height.

The screws allow you to adjust the level to the thickness of the tiles or vinyl floor.

### Built-in odour trap.

No foul smelling air from the drain. A built-in spring ensures that the water trap always stays sealed, even if the trap is empty.

### Highly waterproof.

The clamping frame for connection to the sealing layer and vinyl floor is based on the same principle as the Purus patented clamping ring.



### For all surfaces.

For safe installation in wooden floor structures you use the specially designed installation profile.

## Purus Project



### Dimensions

Length: 300, 600, 700, 800,  
900 or 1000 mm  
Width: 120 mm  
Height: 143\* mm

\*Note that the height depends on which gully you choose.

## Purus Project



An exciting model in the family is Purus Corner, a triangular floor drain that further enhances the opportunity for exciting solutions.

### Dimensions

Right-angled triangle  
300 x 300 x 420 mm  
Height: 143\* mm

# Technical data

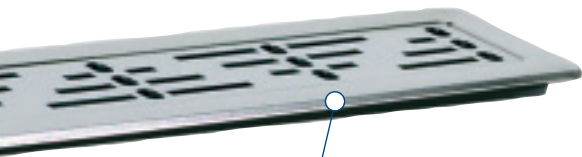

## Elegant and fresh.

The stainless grating suits all environments, and there are patterns for every taste.



## Purus Living outlet/gully

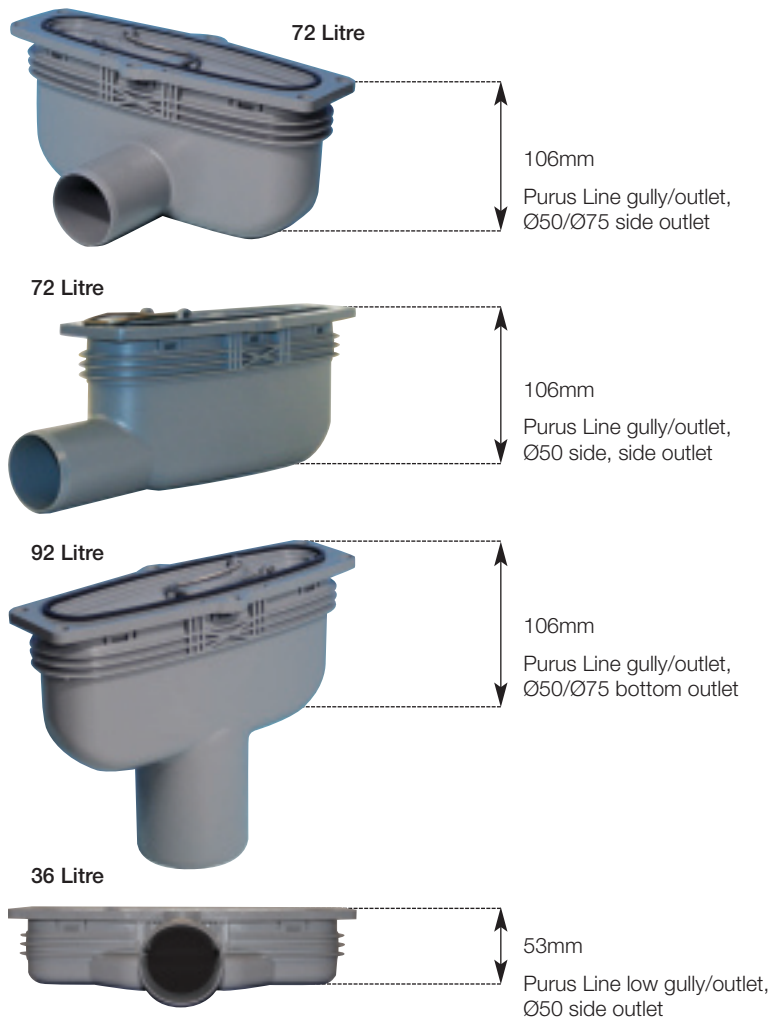

### Use

- Intended to be secured in floor structure (concrete or wood) to avoid any movement between the floor and wall. For use with ceramic tiles and vinyl flooring. Follow the enclosed installation instructions.

### Approval



- Tested by Swedish National Testing and Research Institute (SP) as per EN 1253 and certified by the British Board of Agrément (BBA).

### General description of materials and work. Industrial regulations

- Industrial regulations for tile laying shall be followed for connection of sealing layer and ceramic floor.
- For connection to vinyl floor the relevant industrial regulations shall be followed.
- The requisite industrial regulations shall be followed for heating, water and sanitation.

### Outlet options

- 50mm outlet side, bottom, side side and low.
- 75mm side and bottom.

### Accessories

- Intermediate part for extra inlet Dn 32/40.
- Connectors available.

### Miscellaneous

- Delivered with optional outlet including water trap with air trap, clamping ring for sealing layer/vinyl floor and tile frame with design grating.
- PURUS is a member of the Swedish association of tile manufacturers.
- PURUS is a member of the Swedish national organisation for the flooring industry.
- PURUS is a member of the Swedish safe water installations, which means that the product is adapted to the requisite industrial standards. The supplier guarantees the functionality of the product if the industrial regulations and installation instructions are followed.
- PURUS products can be used in conjunction with preformed trays that create the gradient for both the Purusline and the Minimax products and Purus also recommend the use of a PCI Tanking Kit System for waterproofing the wet area (contact Purus for full details, see back page).

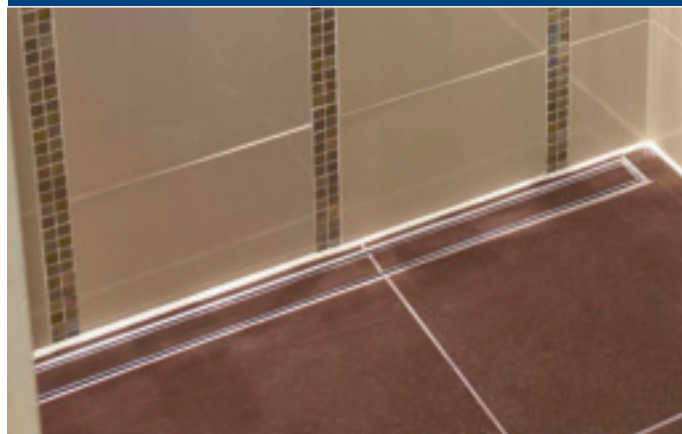

# Purus Project

Measures for different lengths

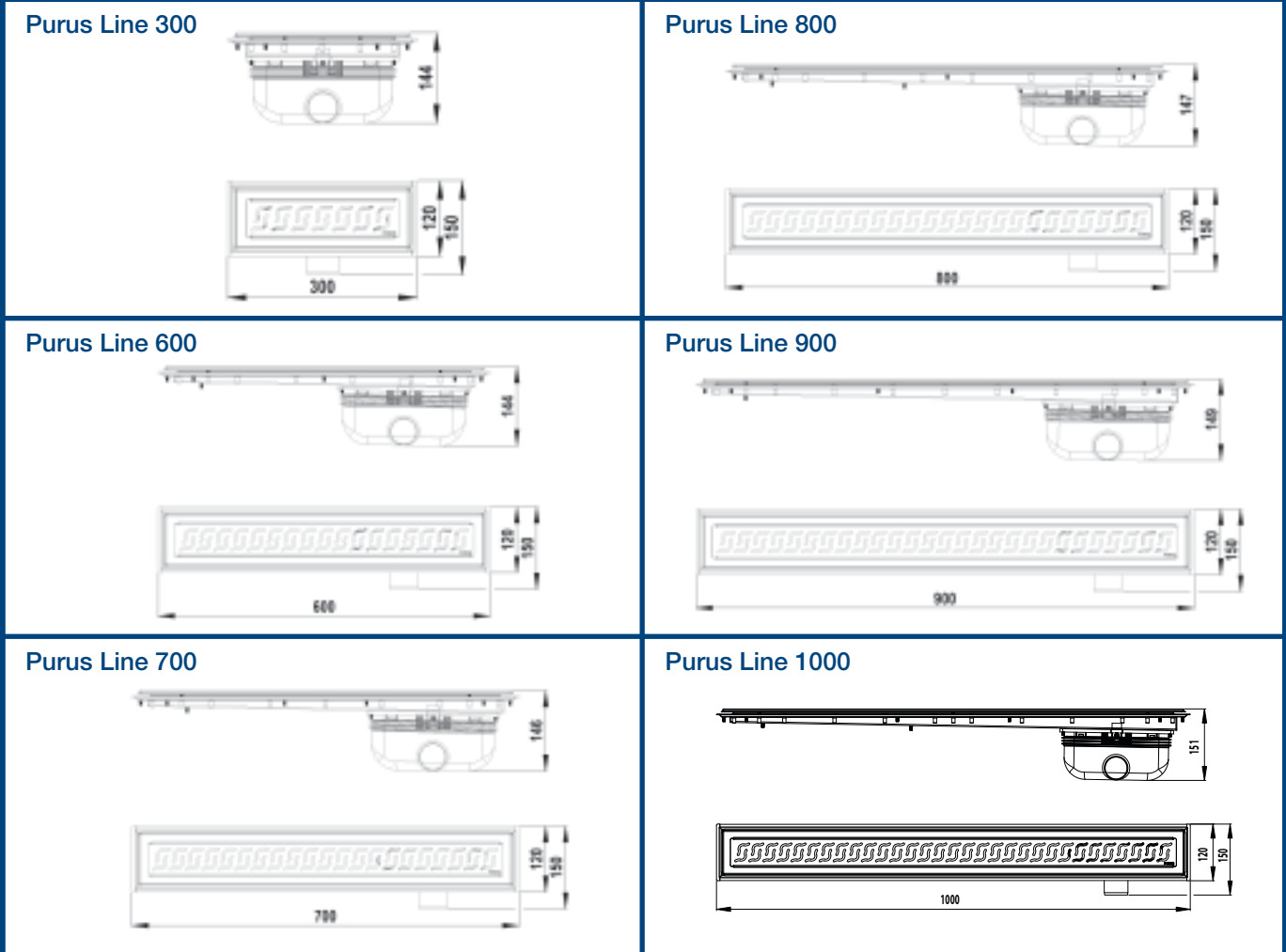

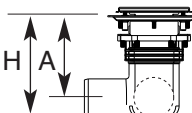
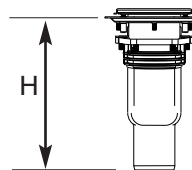
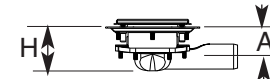
Gully type	Dim	Length mm:					
		300	600	700	800	900	1000
 <b>Side-/Side Side outlet</b> Ø50 og Ø75 H: Ø50 A: Ø75 A:		132	132	134	136	137	139
		107	107	109	111	112	114
		95	95	97	99	100	102
 <b>Bottom outlet</b> Ø50 H: Ø75 H:		187	187	188	190	192	193
		212	212	213	215	217	219
 <b>Low gully</b> Ø50 H: Ø50 A:		79	79	81	83	84	86
		54	54	56	58	59	61



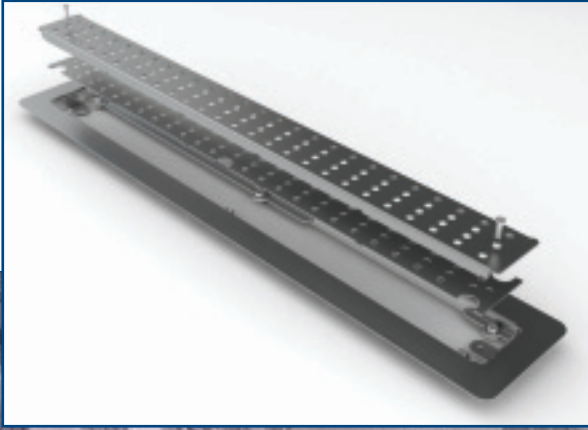

# miniMAX for vinyl or tiled flooring

Floor drain and outlet with extra low profile

PURUS miniMAX has extra low profile – 76mm – and a special designed water trap with NOOD function. The drain can be dried out, but no foul air comes up through the drain, because the spring-loaded trap keeps closed.

The water trap is easily removed by pulling up with the automatically raised handle.

The miniMAX works as an outlet without the water trap.

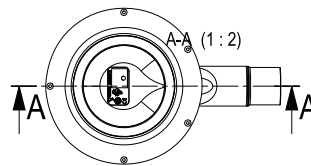
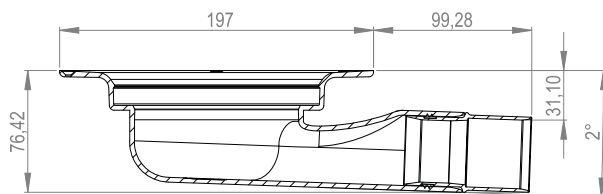

Product, description	Dimension	Art. no.
miniMAX 50, floor drain incl. water trap	Ø130, Ø50 mm	7113764 UK
Water trap miniMAX NOOD	Ø130 mm	7113765
Solvent weld adapter	1 1/2 inch	52576
Art Deco grating, plastic	Ø130 mm	7138447
Clamping ring 130	Ø130 mm	7141316
Purus Knife 130	Ø130 mm	7113605
Locking for plastic grating		7138417
Locking for stainless grating		7138426
Design grating, stainless, Wave for Vinyl	Ø130 mm	7138394
PK 155, square design gratings, stainless for Tile	155 x 155 mm	
PK 175, square design gratings, stainless for Tile	175 x 175 mm	
Maxxus tray Floor Formers	Various	
Minimax Two Part Gulley	Ø130, Ø50 mm	52719



## Tile Adaptor Grates



Platinum

Tile Insert

Twist

## Maxxus Tray

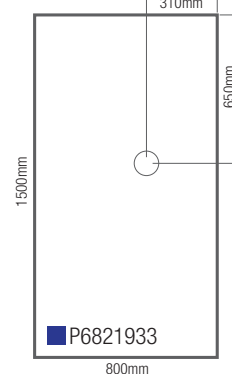
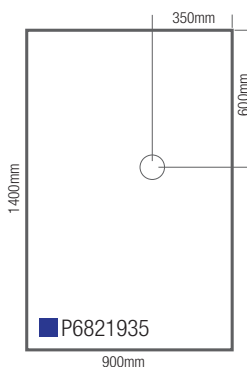
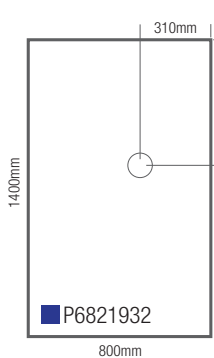
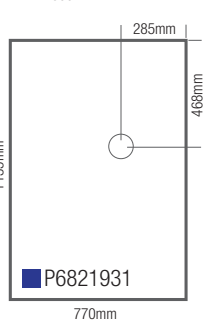
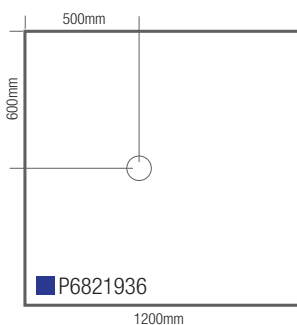
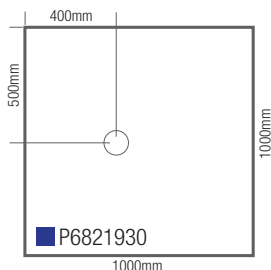
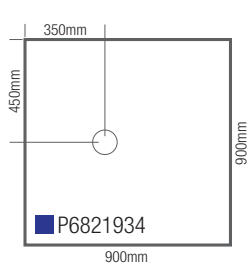

Load bearing to 470kg

## Round Vinyl Grates



Purus design gratings for miniMAX and Mini Brage for ceramic tiles. Make a new look in your bathroom with a design grating on the floor drain. Available in a number of patterns...



Drop



Wave



Classic



Art Deco



Calypso



Globe

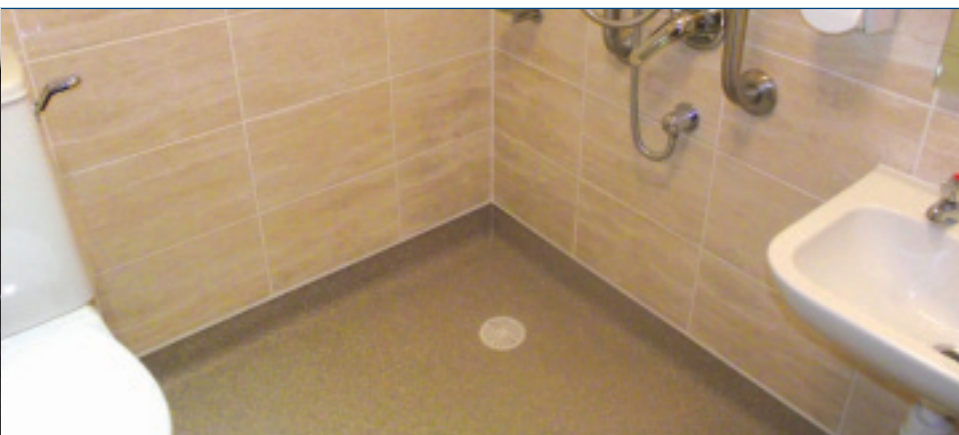

# Floor drain

## Mini Brage 50/110

Wetroom Floor drain with vertical outlet for Vinyl and Ceramic Tiled Floors

Floor drain with bottom outlet of polypropylene (PP). Capacity acc. to EN 1253 – outlet 50 mm, 48 l/min. PURUS Mini Brage has a diameter of 130 mm. Complete floor drain incl. Flexi Nood trap, grating and clamping ring. Nood trap prevents foul air even when dry.



7113538UK-F  
Mini Brage 110

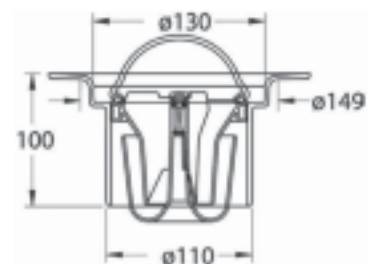

7138414  
Flexi Nood water trap



7113539UK  
Mini Brage 50

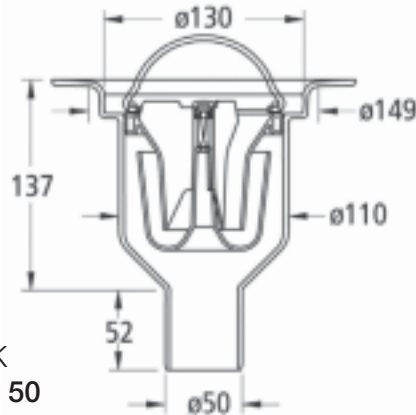

Product, description	Dimension	Art. no.
Mini Brage 50 incl. Flexi Nood trap, reducer	Ø130, Ø50 mm	7113539UK
Mini Brage 50 incl. Flexi Nood trap	Ø130, Ø50 mm	7113539UK-F
Mini Brage 110 incl. Flexi Nood trap	Ø130, Ø110 mm	7113538UK-F
Flexi - NOOD, water trap	Ø130 mm	7138414
Art Deco grating, plastic	Ø130 mm	7138447
Design grating, stainless, Wave for Vinyl	Ø130 mm	7138394
Clamping ring 130	Ø130 mm	7141316
Purus Knife 130	Ø130 mm	7113605
Locking for plastic grating		7138417
Locking for stainless grating		7138426

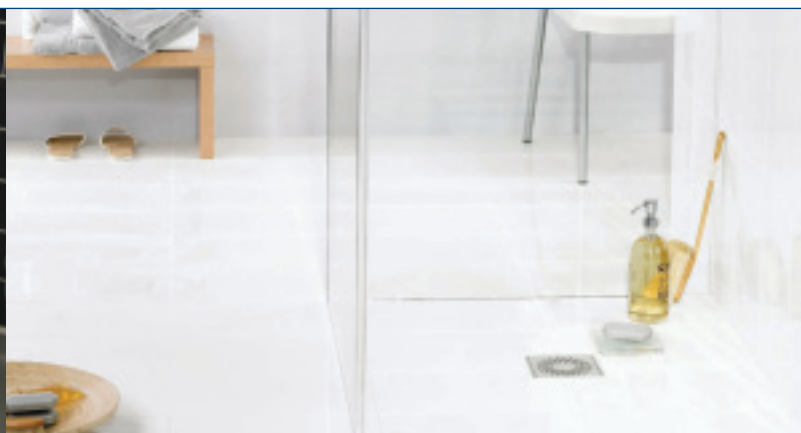

# Purus Industrial Gullies

Bespoke sizes available

Purus Industrial Gullies is a new stainless channel which has various optional models of gratings to fit in the environment where it will be installed. The suspension device for the grating gives unique hygienic advantages as the risk of accumulation of bacteria is minimal.

Food manufacturing, food preparation, pharmaceutical plants, hospitals, laboratories, spa-hotels, public baths, public kitchens, passages, garages and different kinds of industrial environments are examples of places for installation the Purus Industrial Gullies. It is perfect for environments where well-thought-out architecture and design is required but also high demands for function and quality.

Also see the new Industrial Gully brochure.

Purus Industrial Gullies come in three widths: 110, 200 and 300mm wide, and in varying lengths. Please ask for details.

Bespoke sizes are available upon request.

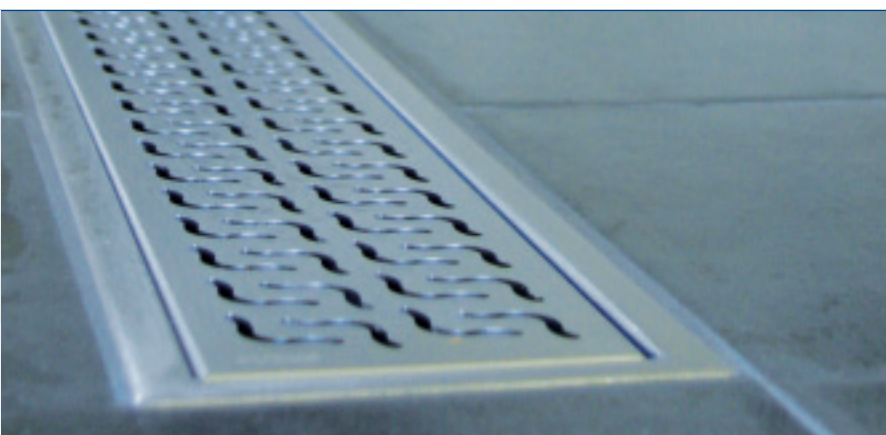

Grating: L15  
Flooring: Vinyl



Grating: Wave  
Flooring: Tiled



Grating: Wave  
Flooring: Resin



Grating: Tile  
Flooring: Tiled



Grating: Steel  
Flooring: Concrete



## Purus Air Admittance Valves



# Purus Plumbing Products

## Pipe Connectors



## Pipe Holders



## Purus Basin Outlets



## Purus Urinal Waste



Dimensions for various connections available at [www.purusgroup.com](http://www.purusgroup.com)

# PUM

## Purus Universal Membrane

PUM, Purus Universal Membrane, is a new technology that provides several new possibilities for different applications and environments with drainage systems.

PUM, Purus Universal Membrane, is a new revolutionary membrane which stops foul air coming up through the drainage system. The new technique saves space without reducing the flow capacity and is also functioning as an air admittance valve when there is a negative pressure in the drainage system (secondary air ventilation). This gives much better flow in the drainage pipe. PUM works also to a certain extent as a back flow stop. The basin outlet works especially well with wall hung units.



### PUM Valve outlet 1 1/4" Basin

The PUM valve outlet is replacing the old traditional water trap. It saves space and is easy to clean. Metallised plastic cover Ø64 mm. Incl. grating. Valve height: 62 mm. Flow capacity: ~0,6 l/s.



Basin

### PUM Valve outlet 1 1/2" Basin/Urinal

Can be used with or without waterflush and still stops foul air. Stainless cover Ø80 mm. Removable grating. Valve height: 43 mm. Flow capacity: ~0,8 l/s.



Basin / Urinal

# PURUS

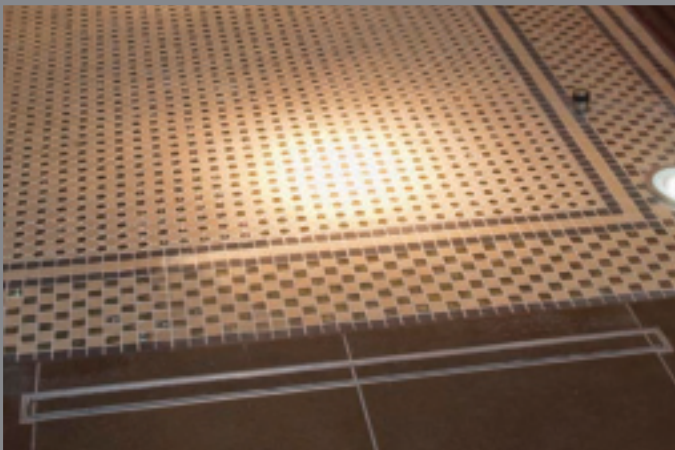

Our ongoing product development may entail changes in version, design and construction, and we reserve the right to make such changes.

Purus Ltd.  
Suite 6, Arena Park, Tarn Lane,  
Scarcroft, Leeds LS17 9BF

Tel: +44 (0) 113 289 3172  
+44 (0) 844 800 1651  
Fax: +44 (0) 113 289 3778

info@purusgroup.com  
www.purusgroup.com  
www.purus.se/en-gb